

# CAN Input FDE4 4x Digital Input

Type of Product: DV-CANFDE4-01

## 1 Introduction

Field bus modules FDE4 are input modules with four inputs that can be used as contact or voltage inputs.

The input state is transmitted via the CAN Bus as soon as an input changes its state.

This module can be combined with one or more output modules of type DV-CANFRAS4-01 by connecting them via CAN Bus. The output state of the relays module with the same address will be set according to the input state of this digital input module. No additional control unit is necessary.

Alternatively the CAN Bus modules can act as input extension for computers with CAN Bus. For example a Touchpanel Computer TP1000 can be used to read the input states.

You can use the software libraries from Wilke Technology to shorten the software development time.

## 2 Applications

- Transparent IO combinations connected via CAN Bus
- Additional Inputs for TP1000 Touchpanel Computers
- Additional Inputs for TDR CPU Modules
- reading state of switches Via CAN Bus

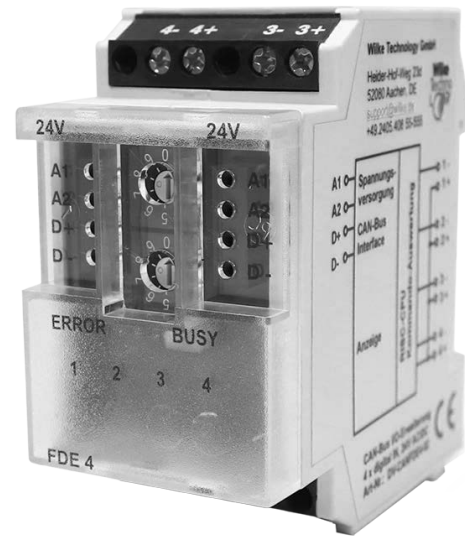

## 3 Features

- 4 Digital Inputs
- Contact or Voltage Input
- CAN 2.0B passive Interface
- 20V...28V Supply Voltage
- 6 Status LEDs

# CAN Input FDE4 4x Digital Input



Type of Product: DV-CANFDE4-01

Technical Documentation

## 4 Contents

1 Introduction.....	1
2 Applications.....	1
3 Features.....	1
4 Contents.....	2
5 Control Elements.....	3
5.1 Baud Rate Select.....	3
5.2 CAN – ID Select.....	4
5.2.1 Module Address.....	4
5.2.2 Other Identifier bits.....	4
5.3 Status LEDs.....	4
6 Connectors.....	5
6.1 Digital Inputs.....	5
6.2 Scheme.....	5
6.3 CAN Bus Connection.....	5
6.4 Power Supply.....	6
7 Technical Specification.....	7
7.1 Absolute maximum Ratings.....	7
7.2 Electrical Specifications.....	7
7.3 Mechanical Specifications.....	8
8 Application example.....	8
9 Document History.....	8

# CAN Input FDE4 4x Digital Input

Type of Product: DV-CANFDE4-01

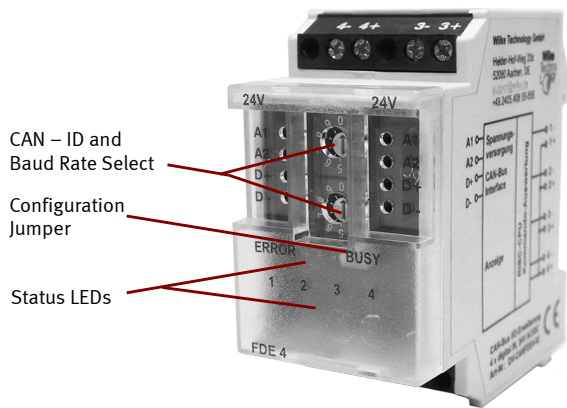

- switch on the power supply of the module. the module will store the selected baud rate into its EEPROM
- switch off the power supply again
- remove the jumper
- mount the transparent front panel
- select the CAN - ID using the rotary switches (see section below)

## 5 Control Elements

### 5.1 Baud Rate Select

For control and communication via Can all connected devices have to use the same baud rate. The maximum baud rate which can be used depends on the length of the CAN Bus cable. The longer the cable is, the smaller the baud rate can be.

The baud rate of this CAN Bus module can be set by the following steps:

- switch off the power supply of the module
- remove the transparent front panel
- set the configuration jumper to the middle of the 4 pole header connector.
- set the top rotary switch to position 0
- set the bottom rotary switch to one of the positions 2, 3, 4, 5, or 6 according to the desired baud rate

Length of CAN Bus Cable	maximum baud rate	position of bottom rotary switch
2500m	20 kBit/s	2
1000m	50 kBit/s	3
500m	125 kBit/s	4
250m	250 kBit/s	5
100m	500 kBit/s	6

## 5.2 CAN – ID Select

The CAN – IO module uses identifiers which are 11 bits long according to CAN 2.0A.

CAN Messages with 29 bits identifiers which are specified in Specification 2.0B are ignored.

The Identifier contains a constant to select between digital and analog modules (bit 10), a module address (bit 3 to 9) and a number for the message kind (bit 0 to 2)

CAN Messages which are not assigned to this module should have identifiers that differ in bit 10 or in bits 3 to 9 from the selected module address.

	Identifier										
Bit	10	9	8	7	6	5	4	3	2	1	0
		module address							message kind		
used values	0	1...99 <sub>dec</sub> 01...63 <sub>hex</sub> selected with rotary switches							0...2		

### 5.2.1 Module Address

A module address between 1 and 99 can be selected with the rotary switches.

The value of the upper switch will be multiplied with 10 and added to the value of the bottom switch. Do not select module address 0.

The module address will be used in the identifier bits 3 to 9.

#### Example:

upper switch:5  
bottom switch 2

module address = 52<sub>dec.</sub> (=34<sub>hex</sub> = 0110100<sub>bin</sub>)

Identifier: 001101000kk<sub>bin</sub>

kk: depends on message kind

### 5.2.2 Other Identifier bits

The value of bit 10 is always 0 for addressing this module type.

With bit 0 to 3 the message kind is selected. This module differs between 3 message kinds:

value	message kind
0	process data
1	service data
2	control data
other values	not used

### 5.3 Status LEDs

The four yellow status LEDs indicate the state of the four digital inputs: If a high level voltage is attached to the 1-, 2-, 3- or 4- terminal or if the contact is closed, then the corresponding LED will lit.

The green LED lits if the module is powered on. It flashes each time when a message is received correctly.

The module expects to get CAN messages in regular time intervals. If this messages cannot be received correctly then the red error LED will lit.

If module address 0 is selected, or if you use more than one digital input module with the same module address on the bus then the red error LED will flash.

# CAN Input FDE4 4x Digital Input

Type of Product: DV-CANFDE4-01

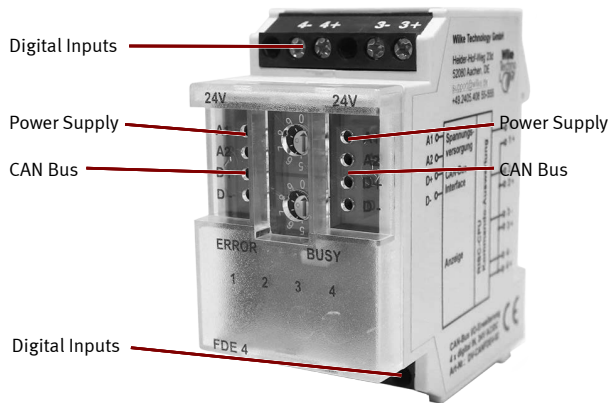

## 6.3 CAN Bus Connection

The CAN Bus is connected to D+ and D- at the front terminal block. Connect the CAN-High signal to D+ and the CAN Low signal to D-.

	4-	4+		3-	3+
A1	24 V AC/DC		A1		
A2	GND		A2		
D+	CANHigh		D+		
D-	CANLow		D-		
1+	1-	2+	2-		

## 6 Connectors

### 6.1 Digital Inputs

The inputs of this module can be used as contact or as voltage input.

Connect the +terminal with the -terminal via a switch or a relay contact to use an input as a contact input.

Connect your voltage signal to the -terminal of this module to use an input as a voltage input.

The terminal block at the left side is looped through to the terminal block of the right side.

The Terminal block can be exchanged with a bridge element to connect a second module that is placed next to this module.

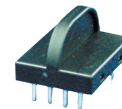

bridge element

### 6.2 Scheme

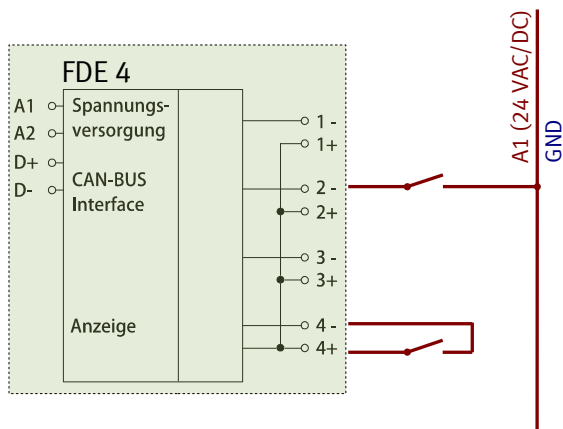

We recommend to use a bus cable with a characteristic wave impedance of 120Ω.

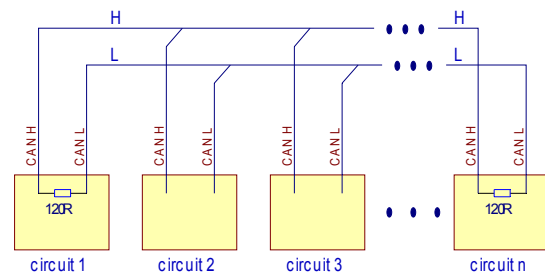

**Note:** The line should be terminated at both ends in its characteristic impedance. Stub lengths off the main line should be kept as short as possible.

You have to connect GND to each module if a separate power supply is used!

# CAN Input FDE4 4x Digital Input



Type of Product: DV-CANFDE4-01

## 6.4 Power Supply

Connect the +pole of the power supply to A1 and the -pole to A2.

The terminal block at the left side is looped through to the terminal block of the right side.

The Terminal block can be exchanged with a bridge element to connect a second module that is placed next to this module.

# CAN Input FDE4 4x Digital Input



Type of Product: DV-CANFDE4-01

## 7 Technical Specification

### 7.1 Absolute maximum Ratings

beyond which permanent damage may occur

Power Supply Voltage <b>V+</b>	28V AC/DC
Input Voltage	<b>V+</b>
operation temperature range	-5°C...+55°C
storage temperature range	-20°C...+70°C

### 7.2 Electrical Specifications

Power Supply Voltage	20V...28V AC/DC
<b>current consumption</b> at AC supply at DC supply	63mA 21mA
<b>Digital Inputs</b> max. Low Level Input Voltage min. High Level Input Voltage Input Impedance	5V 17V approx. 4.6kΩ
<b>CAN Bus</b> standard supported baud rates  Maximum CAN Bus length at 20k bits/s required bus termination at both ends max. nodes	2.0B passive  20k bits/s, 50k bits/s 125k bits/s 500k bits/s  2500m 120Ω 112
<b>Terminal Blocks</b> supply and CAN Bus digital inputs	1.5mm <sup>2</sup> 2.5mm <sup>2</sup>

# CAN Input FDE4 4x Digital Input

Type of Product: DV-CANFDE4-01

## 7.3 Mechanical Specifications

dimensions W x H x L	35mm x 70mm x 65mm
weight	104g
housing	IP40
terminal blocks	IP20

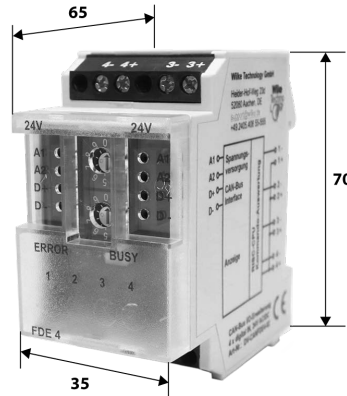

## 8 Application example

Touchpanel Computer TP1000 uses FDE4 as digital inputs

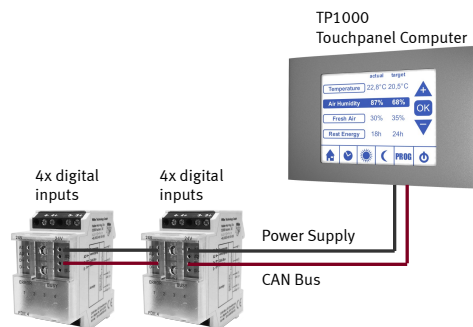

Touchpanel Software?

download software libraries at [www.wilke.de](http://www.wilke.de) or ask our support team: [support@wilke.de](mailto:support@wilke.de)

## 9 Document History

Document Version	Description
V001	first version